

TMT7N60 / TMTF7N60 N-CHANNEL POWER MOSFET

<p>General Description</p> <p>The TMT7N60 & TMTF7N60 have been fabricated using an advanced high voltage MOSFET process that is designed to deliver high levels of performance and robustness in popular AC-DC applications. By providing low $R_{DS(on)}$, C_{iss} and C_{rss} along with guaranteed avalanche capability these parts can be adopted quickly into new and existing offline power supply designs.</p>	<p>Product Summary</p> <table border="0"> <tr> <td>V_{DS}</td> <td>600V</td> </tr> <tr> <td>I_D (at $V_{GS}=10V$)</td> <td>7A</td> </tr> <tr> <td>$R_{DS(on)}$ (at $V_{GS}=10V$)</td> <td>< 1.2Ω</td> </tr> </table> <p>100% UIS Tested 100% R_g Tested</p> 	V_{DS}	600V	I_D (at $V_{GS}=10V$)	7A	$R_{DS(on)}$ (at $V_{GS}=10V$)	< 1.2 Ω
V_{DS}	600V						
I_D (at $V_{GS}=10V$)	7A						
$R_{DS(on)}$ (at $V_{GS}=10V$)	< 1.2 Ω						

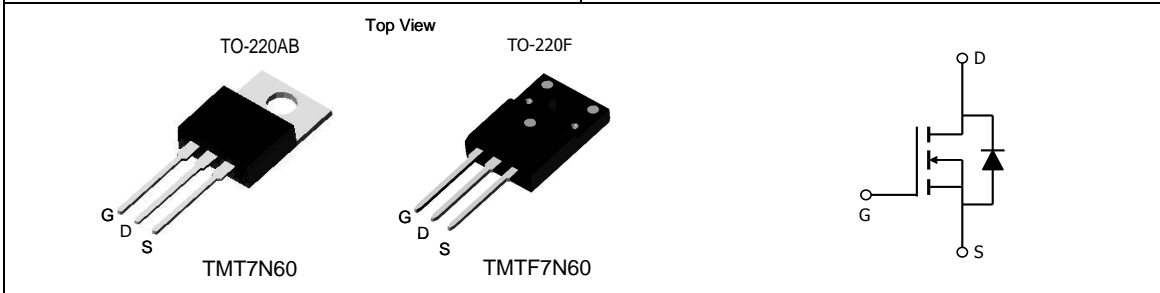

Absolute Maximum Ratings $T_A=25^\circ C$ unless otherwise noted

Parameter	Symbol	TMT7N60	TMTF7N60	Units	
Drain-Source Voltage	V_{DS}	600		V	
Gate-Source Voltage	V_{GS}	± 30		V	
Continuous Drain Current	I_D	$T_C=25^\circ C$	7	A	
		$T_C=100^\circ C$	4.8		
Pulsed Drain Current ^C	I_{DM}	28			
Avalanche Current ^C	I_{AR}	3		A	
Repetitive avalanche energy ^C	E_{AR}	135		mJ	
Single pulsed avalanche energy ^G	E_{AS}	270		mJ	
MOSFET dv/dt ruggedness	dv/dt	50		V/ns	
Peak diode recovery dv/dt		5			
Power Dissipation ^B	P_D	$T_C=25^\circ C$	192	38.5	W
		Derate above $25^\circ C$	1.54	0.3	W/ $^\circ C$
Junction and Storage Temperature Range	T_J, T_{STG}	-55 to 150		$^\circ C$	
Maximum lead temperature for soldering purpose, 1/8" from case for 5 seconds	T_L	300		$^\circ C$	

Thermal Characteristics

Parameter	Symbol	TMT7N60	TMTF7N60	Units
Maximum Junction-to-Ambient ^{A,D}	$R_{\theta JA}$	65	65	$^\circ C/W$
Maximum Case-to-sink ^A	$R_{\theta CS}$	0.5	--	$^\circ C/W$
Maximum Junction-to-Case	$R_{\theta JC}$	0.65	3.25	$^\circ C/W$

* Drain current limited by maximum junction temperature.

Electrical Characteristics (T_J=25°C unless otherwise noted)

Symbol	Parameter	Conditions	Min	Typ	Max	Units
STATIC PARAMETERS						
BV _{DSS}	Drain-Source Breakdown Voltage	I _D =250μA, V _{GS} =0V, T _J =25°C	600			V
BV _{DSS} /ΔT _J	Breakdown Voltage Temperature Coefficient	I _D =250μA, V _{GS} =0V		0.72		V/°C
I _{DSS}	Zero Gate Voltage Drain Current	V _{DS} =600V, V _{GS} =0V V _{DS} =480V, T _J =125°C			1 10	μA
I _{GSS}	Gate-Body leakage current	V _{DS} =0V, V _{GS} =±30V			±100	nA
V _{GS(th)}	Gate Threshold Voltage	V _{DS} =5V, I _D =250μA	3	3.9	4.5	V
R _{DS(ON)}	Static Drain-Source On-Resistance	V _{GS} =10V, I _D =3.5A		1	1.2	Ω
g _{FS}	Forward Transconductance	V _{DS} =40V, I _D =3.5A		12		S
V _{SD}	Diode Forward Voltage	I _S =1A, V _{GS} =0V		0.74	1	V
I _S	Maximum Body-Diode Continuous Current				7	A
I _{SM}	Maximum Body-Diode Pulsed Current				28	A
DYNAMIC PARAMETERS						
C _{iss}	Input Capacitance	V _{GS} =0V, V _{DS} =25V, f=1MHz	685	861	1035	pF
C _{oss}	Output Capacitance		65	84	100	pF
C _{rss}	Reverse Transfer Capacitance		5.2	6.6	7.9	pF
R _g	Gate resistance	V _{GS} =0V, V _{DS} =0V, f=1MHz	3	4.1	6.2	Ω
SWITCHING PARAMETERS						
Q _g	Total Gate Charge	V _{GS} =10V, V _{DS} =480V, I _D =7A	19.3	23	28	nC
Q _{gs}	Gate Source Charge		3.8	5	5.5	nC
Q _{gd}	Gate Drain Charge		9.3	11.2	13.5	nC
t _{D(on)}	Turn-On Delay Time	V _{GS} =10V, V _{DS} =300V, I _D =7A, R _G =25Ω		25		ns
t _r	Turn-On Rise Time			49.5		ns
t _{D(off)}	Turn-Off Delay Time			51.5		ns
t _f	Turn-Off Fall Time			43.5		ns
t _{rr}	Body Diode Reverse Recovery Time	I _F =7A, dI/dt=100A/μs, V _{DS} =100V	212	255	306	ns
Q _{rr}	Body Diode Reverse Recovery Charge	I _F =7A, dI/dt=100A/μs, V _{DS} =100V	2.0	2.6	3.1	μC

A. The value of R_{θJA} is measured with the device in a still air environment with T_A=25°C.

B. The power dissipation P_D is based on T_{J(MAX)}=150°C, using junction-to-case thermal resistance, and is more useful in setting the upper dissipation limit for cases where additional heatsinking is used.

C. Repetitive rating, pulse width limited by junction temperature T_{J(MAX)}=150°C, Ratings are based on low frequency and duty cycles to keep initial T_J=25°C.

D. The R_{θJA} is the sum of the thermal impedance from junction to case R_{θJC} and case to ambient.

E. The static characteristics in Figures 1 to 6 are obtained using <300 μs pulses, duty cycle 0.5% max.

F. These curves are based on the junction-to-case thermal impedance which is measured with the device mounted to a large heatsink, assuming a maximum junction temperature of T_{J(MAX)}=150°C. The SOA curve provides a single pulse rating.

G. L=60mH, I_{AS}=3A, V_{DD}=150V, R_G=25Ω, Starting T_J=25°C

TYPICAL ELECTRICAL AND THERMAL CHARACTERISTICS

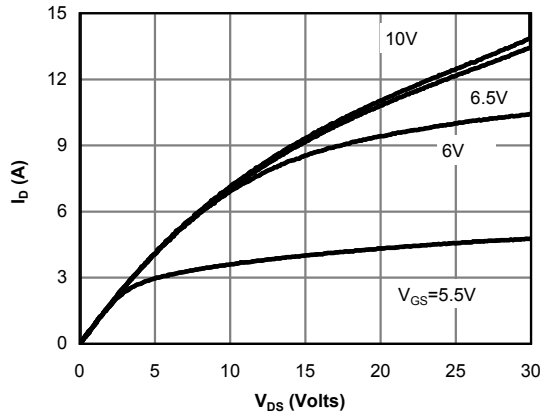

Fig 1: On-Region Characteristics

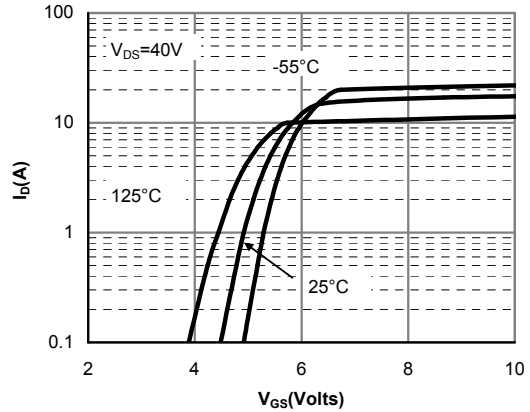

Figure 2: Transfer Characteristics

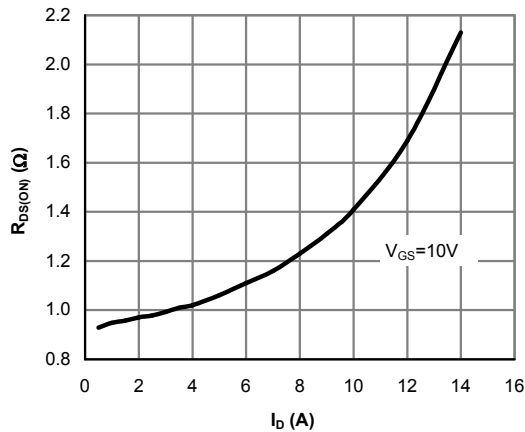

Figure 3: On-Resistance vs. Drain Current and Gate Voltage

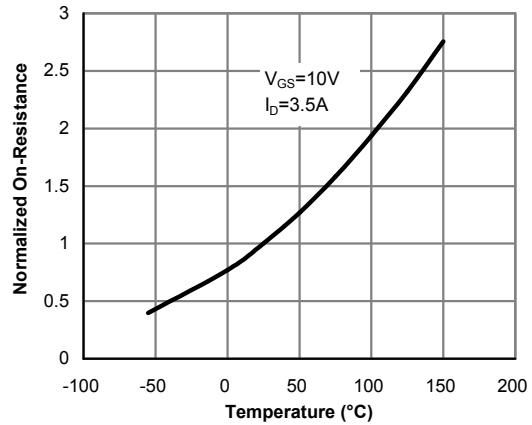

Figure 4: On-Resistance vs. Junction Temperature

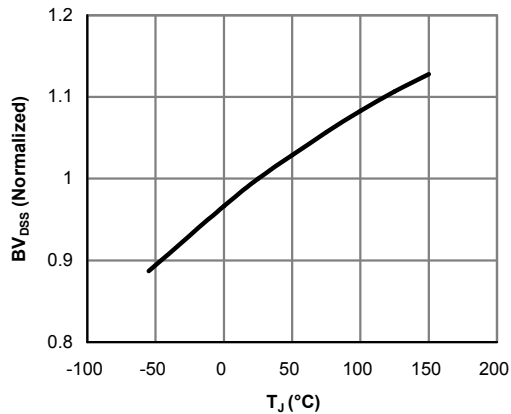

Figure 5: Break Down vs. Junction Temperature

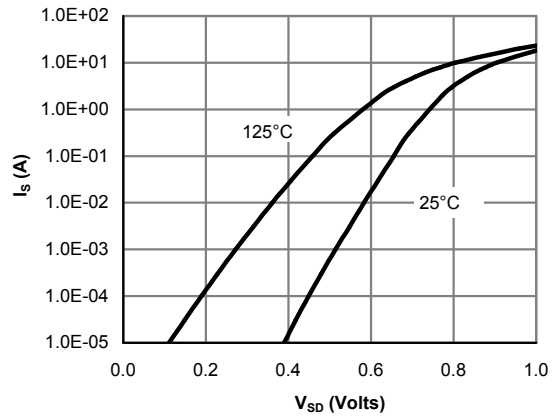

Figure 6: Body-Diode Characteristics (Note E)

TYPICAL ELECTRICAL AND THERMAL CHARACTERISTICS

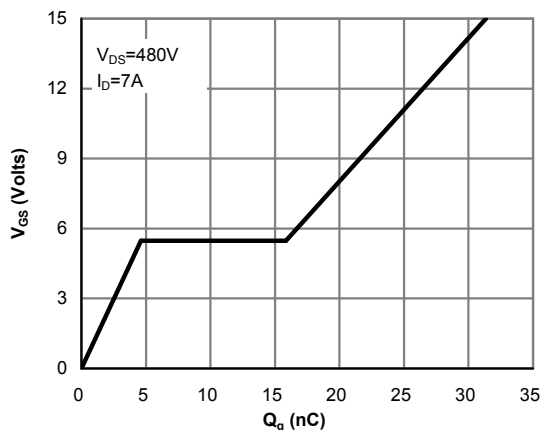

Figure 7: Gate-Charge Characteristics

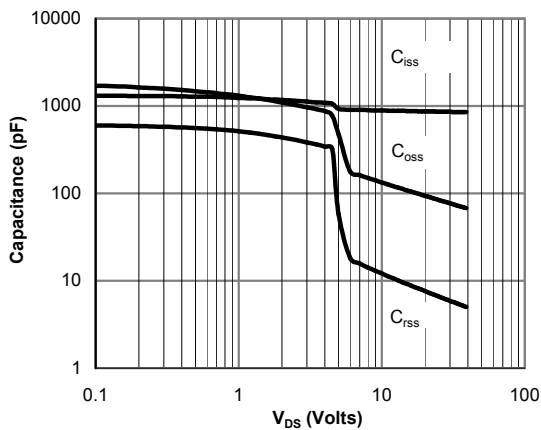

Figure 8: Capacitance Characteristics

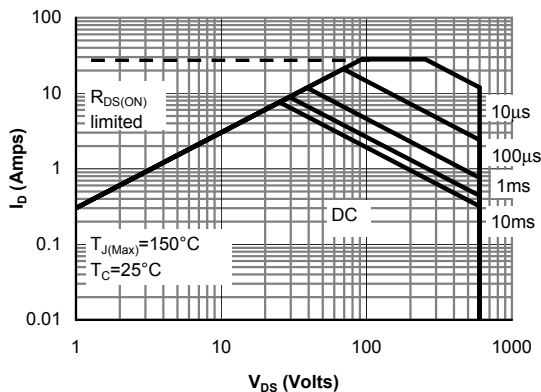

Figure 9: Maximum Forward Biased Safe Operating Area for AOT7N60 (Note F)

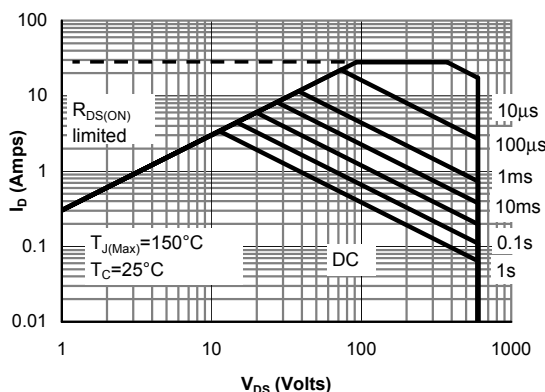

Figure 10: Maximum Forward Biased Safe Operating Area for AOTF7N60 (Note F)

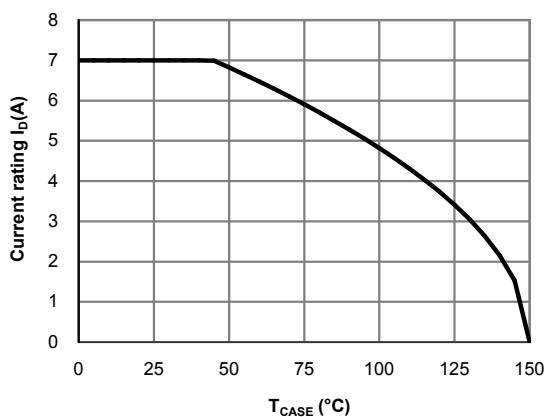

Figure 11: Current De-rating (Note B)

TYPICAL ELECTRICAL AND THERMAL CHARACTERISTICS

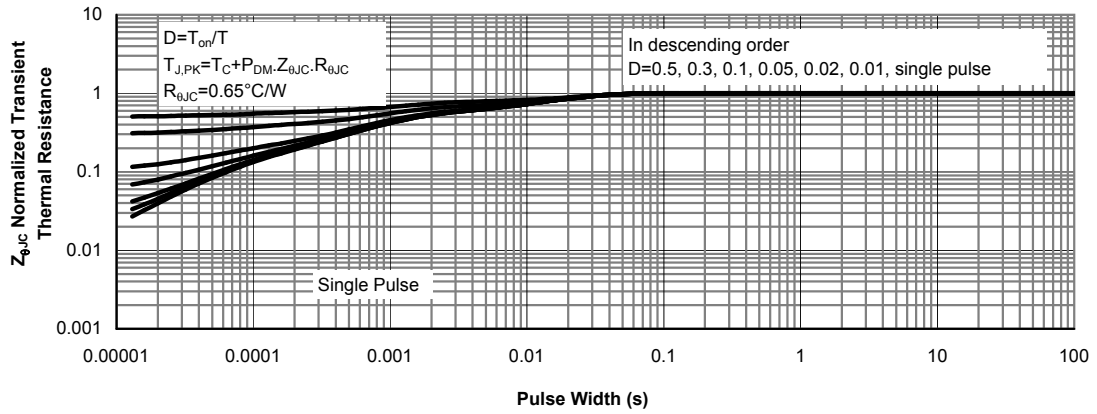

Figure 12: Normalized Maximum Transient Thermal Impedance for AOT7N60 (Note F)

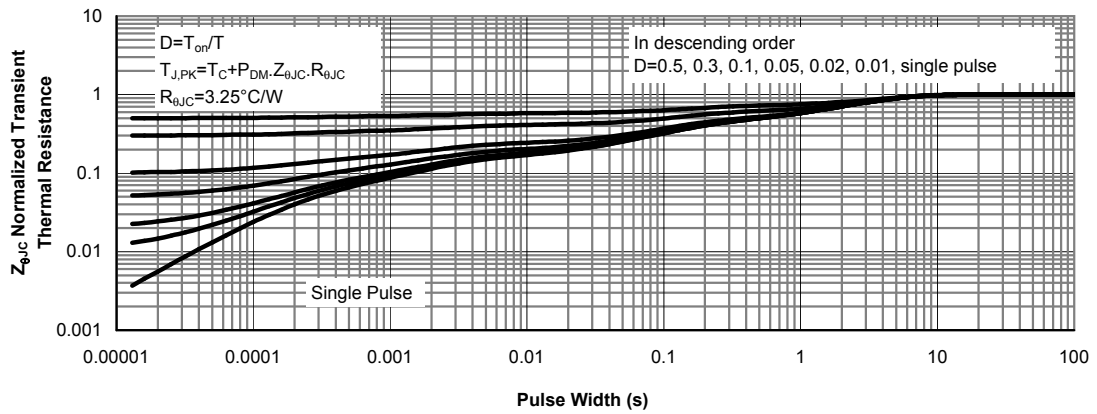
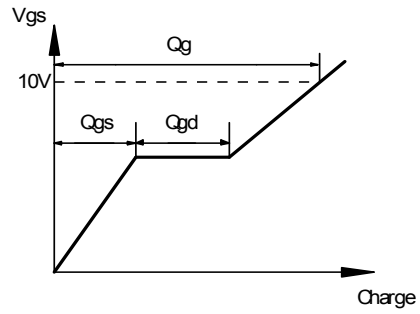
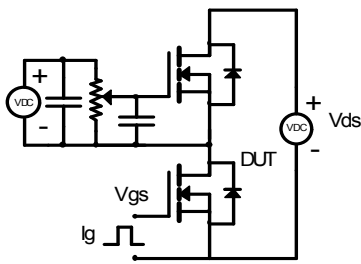
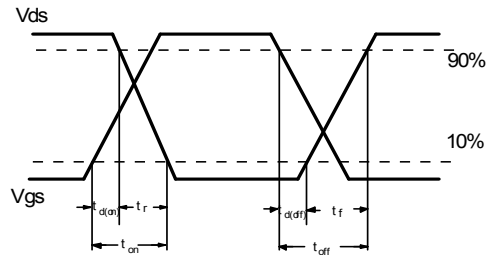
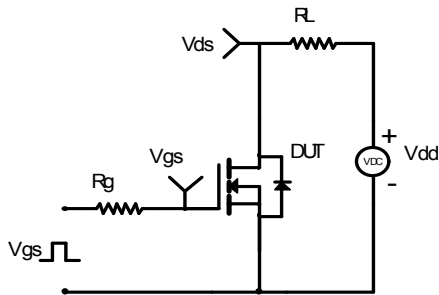

Figure 13: Normalized Maximum Transient Thermal Impedance for AOTF7N60 (Note F)

Gate Charge Test Circuit & Waveform



Resistive Switching Test Circuit & Waveforms



Unclamped Inductive Switching (UIS) Test Circuit & Waveforms

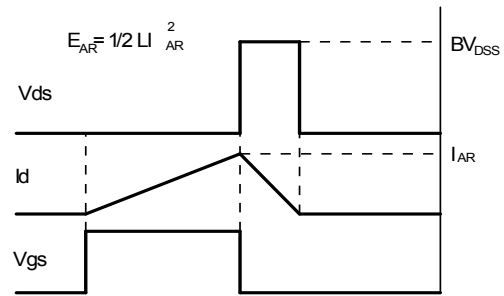
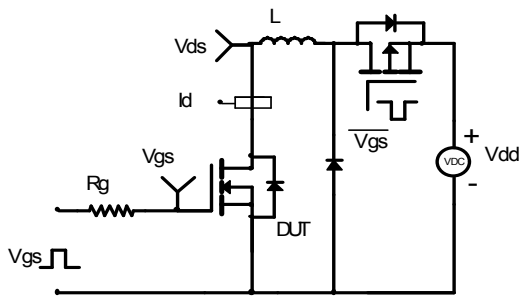

Diode Recovery Test Circuit & Waveforms

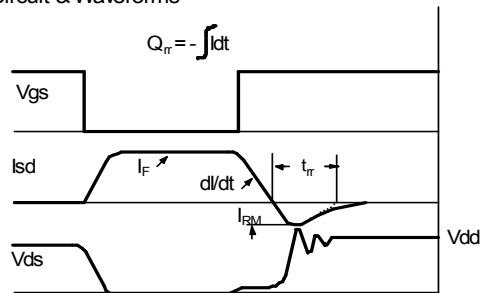
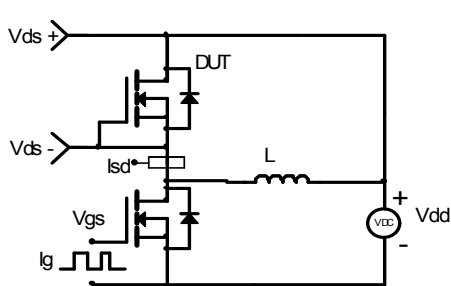

TO-220AB Package Information

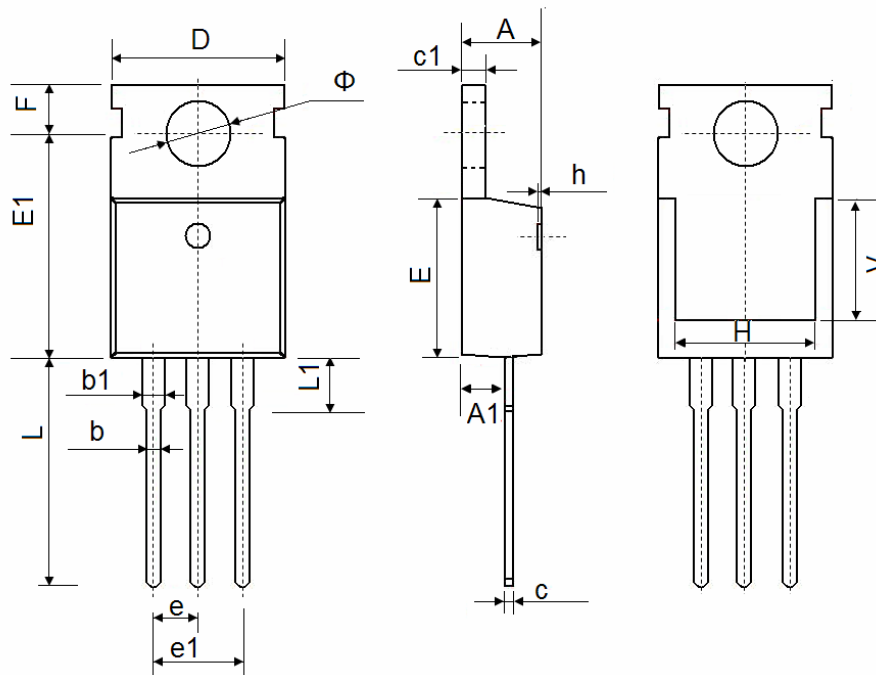

Symbol	Dimensions In Millimeters		Dimensions In Inches	
	Min.	Max.	Min.	Max.
A	4.400	4.600	0.173	0.181
A1	2.250	2.550	0.089	0.100
b	0.710	0.910	0.028	0.036
b1	1.170	1.370	0.046	0.054
c	0.330	0.650	0.013	0.026
c1	1.200	1.400	0.047	0.055
D	9.910	10.250	0.390	0.404
E	8.9500	9.750	0.352	0.384
E1	12.650	12.950	0.498	0.510
e	2.540 TYP.		0.100 TYP.	
e1	4.980	5.180	0.196	0.204
F	2.650	2.950	0.104	0.116
H	7.900	8.100	0.311	0.319
h	0.000	0.300	0.000	0.012
L	12.900	13.400	0.508	0.528
L1	2.850	3.250	0.112	0.128
V	7.500 REF.		0.295 REF.	
Φ	3.400	3.800	0.134	0.150

TO-220F Package Information

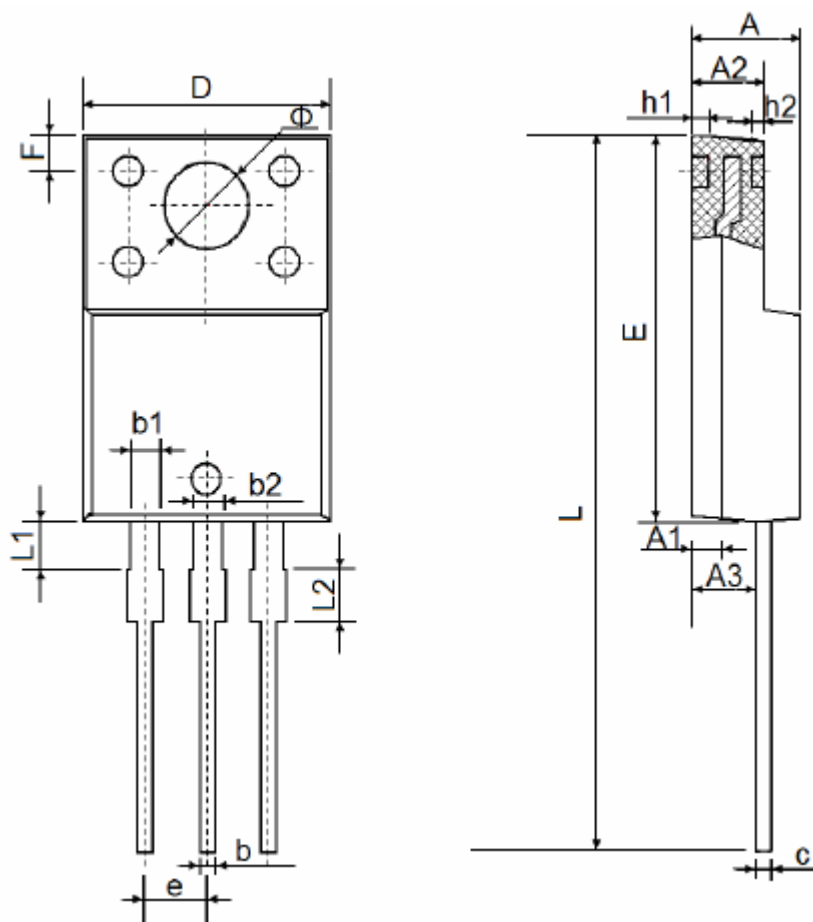

Symbol	Dimensions In Millimeters		Dimensions In Inches	
	Min.	Max.	Min.	Max.
A	4.300	4.700	0.169	0.185
A1	1.300REF		0.051REF	
A2	2.800	3.200	0.110	0.126
A3	2.500	2.900	0.098	0.114
b	0.500	0.750	0.020	0.030
b1	1.100	1.350	0.043	0.053
b2	1.500	1.750	0.059	0.069
c	0.500	0.750	0.020	0.030
D	9.960	10.360	0.392	0.408
E	14.800	15.200	0.583	0.598
e	2.540TYP.		0.100TYP	
F	2.700REF		0.106REF	
Φ	3.500REF		0.138REF	
h1	0.800REF		0.031REF	
h2	0.500REF		0.020REF	
L	28.000	28.400	1.102	1.118
L1	1.700	1.900	0.067	0.075
L2	1.900	2.100	0.075	0.083