
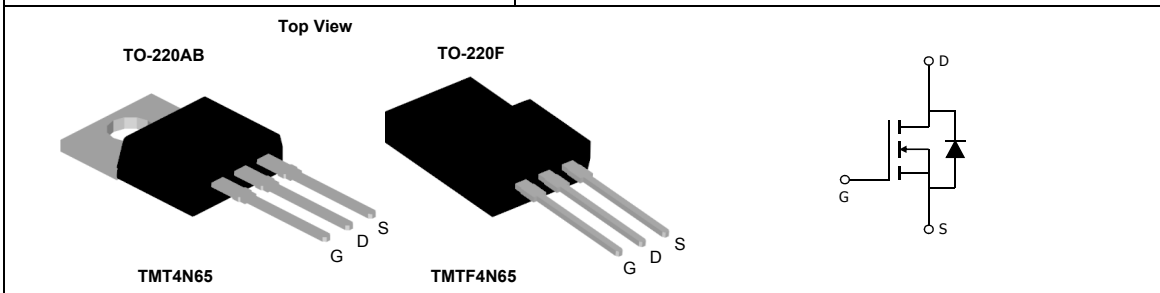


## TMT4N65 / TMTF4N65 N-CHANNEL POWER MOSFET

<p><b>General Description</b></p> <p>The TMT4N65 &amp; TMTF4N65 have been fabricated using an advanced high voltage MOSFET process that is designed to deliver high levels of performance and robustness in popular AC-DC applications. By providing low <math>R_{DS(on)}</math>, <math>C_{iss}</math> and <math>C_{rss}</math> along with guaranteed avalanche capability these parts can be adopted quickly into new and existing offline power supply designs.</p>	<p><b>Product Summary</b></p> <table style="width: 100%; border: none;"> <tr> <td style="border: none;"><math>V_{DS}</math></td> <td style="border: none; text-align: right;">650V</td> </tr> <tr> <td style="border: none;"><math>I_D</math> (at <math>V_{GS}=10V</math>)</td> <td style="border: none; text-align: right;">4A</td> </tr> <tr> <td style="border: none;"><math>R_{DS(on)}</math> (at <math>V_{GS}=10V</math>)</td> <td style="border: none; text-align: right;">&lt; 2.2<math>\Omega</math></td> </tr> </table> <p>100% UIS Tested 100% <math>R_g</math> Tested</p> <div style="text-align: right;">  </div>	$V_{DS}$	650V	$I_D$ (at $V_{GS}=10V$ )	4A	$R_{DS(on)}$ (at $V_{GS}=10V$ )	< 2.2 $\Omega$
$V_{DS}$	650V						
$I_D$ (at $V_{GS}=10V$ )	4A						
$R_{DS(on)}$ (at $V_{GS}=10V$ )	< 2.2 $\Omega$						



Absolute Maximum Ratings $T_A=25^\circ\text{C}$ unless otherwise noted				
Parameter	Symbol	TMT4N65	TMTF4N65	Units
Drain-Source Voltage	$V_{DS}$	650		V
Gate-Source Voltage	$V_{GS}$	$\pm 30$		V
Continuous Drain Current	$I_D$	$T_C=25^\circ\text{C}$	4	A
		$T_C=100^\circ\text{C}$	2.7	
Pulsed Drain Current <sup>C</sup>	$I_{DM}$	16		
Avalanche Current <sup>C</sup>	$I_{AR}$	2.5		A
Repetitive avalanche energy <sup>C</sup>	$E_{AR}$	94		mJ
Single pulsed avalanche energy <sup>G</sup>	$E_{AS}$	188		mJ
MOSFET dv/dt ruggedness	dv/dt	50		V/ns
Peak diode recovery dv/dt		5		
Power Dissipation <sup>B</sup>	$P_D$	$T_C=25^\circ\text{C}$	104	35
		Derate above $25^\circ\text{C}$	0.83	0.28
Junction and Storage Temperature Range	$T_J, T_{STG}$	-55 to 150		$^\circ\text{C}$
Maximum lead temperature for soldering purpose, 1/8" from case for 5 seconds	$T_L$	300		$^\circ\text{C}$
Thermal Characteristics				
Parameter	Symbol	TMT4N65	TMTF4N65	Units
Maximum Junction-to-Ambient <sup>A,D</sup>	$R_{\theta JA}$	65	65	$^\circ\text{C}/\text{W}$
Maximum Case-to-sink <sup>A</sup>	$R_{\theta CS}$	0.5	--	$^\circ\text{C}/\text{W}$
Maximum Junction-to-Case	$R_{\theta JC}$	1.2	3.6	$^\circ\text{C}/\text{W}$

<sup>A</sup> Drain current limited by maximum junction temperature.

**Electrical Characteristics (T<sub>J</sub>=25°C unless otherwise noted)**

Symbol	Parameter	Conditions	Min	Typ	Max	Units
<b>STATIC PARAMETERS</b>						
BV <sub>DSS</sub>	Drain-Source Breakdown Voltage	I <sub>D</sub> =250μA, V <sub>GS</sub> =0V, T <sub>J</sub> =25°C	650			V
BV <sub>DSS</sub> /ΔT <sub>J</sub>	Breakdown Voltage Temperature Coefficient	I <sub>D</sub> =250μA, V <sub>GS</sub> =0V		0.69		V/°C
I <sub>DSS</sub>	Zero Gate Voltage Drain Current	V <sub>DS</sub> =650V, V <sub>GS</sub> =0V V <sub>DS</sub> =480V, T <sub>J</sub> =125°C			1 10	μA
I <sub>GSS</sub>	Gate-Body leakage current	V <sub>DS</sub> =0V, V <sub>GS</sub> =±30V			±100	nA
V <sub>GS(th)</sub>	Gate Threshold Voltage	V <sub>DS</sub> =5V, I <sub>D</sub> =250μA	3	4	4.5	V
R <sub>DS(ON)</sub>	Static Drain-Source On-Resistance	V <sub>GS</sub> =10V, I <sub>D</sub> =2A		1.9	2.2	Ω
g <sub>FS</sub>	Forward Transconductance	V <sub>DS</sub> =40V, I <sub>D</sub> =2A		7.4		S
V <sub>SD</sub>	Diode Forward Voltage	I <sub>S</sub> =1A, V <sub>GS</sub> =0V		0.77	1	V
I <sub>S</sub>	Maximum Body-Diode Continuous Current				4	A
I <sub>SM</sub>	Maximum Body-Diode Pulsed Current				16	A
<b>DYNAMIC PARAMETERS</b>						
C <sub>iss</sub>	Input Capacitance	V <sub>GS</sub> =0V, V <sub>DS</sub> =25V, f=1MHz	400	511	615	pF
C <sub>oss</sub>	Output Capacitance		40	51	65	pF
C <sub>rss</sub>	Reverse Transfer Capacitance		3.5	4.4	5.3	pF
R <sub>g</sub>	Gate resistance	V <sub>GS</sub> =0V, V <sub>DS</sub> =0V, f=1MHz	3.3	4.2	6.3	Ω
<b>SWITCHING PARAMETERS</b>						
Q <sub>g</sub>	Total Gate Charge	V <sub>GS</sub> =10V, V <sub>DS</sub> =480V, I <sub>D</sub> =4A		15	18	nC
Q <sub>gs</sub>	Gate Source Charge		3	3.6	nC	
Q <sub>gd</sub>	Gate Drain Charge		7.6	9.1	nC	
t <sub>D(on)</sub>	Turn-On DelayTime	V <sub>GS</sub> =10V, V <sub>DS</sub> =300V, I <sub>D</sub> =4A, R <sub>G</sub> =25Ω		20.2	30	ns
t <sub>r</sub>	Turn-On Rise Time		28.7	42	ns	
t <sub>D(off)</sub>	Turn-Off DelayTime		36	51	ns	
t <sub>f</sub>	Turn-Off Fall Time		27	40	ns	
t <sub>rr</sub>	Body Diode Reverse Recovery Time	I <sub>F</sub> =4A, dI/dt=100A/μs, V <sub>DS</sub> =100V		212	254	ns
Q <sub>rr</sub>	Body Diode Reverse Recovery Charge	I <sub>F</sub> =4A, dI/dt=100A/μs, V <sub>DS</sub> =100V		1.6	1.9	μC

A. The value of R<sub>θJA</sub> is measured with the device in a still air environment with T<sub>A</sub>=25° C.

B. The power dissipation P<sub>D</sub> is based on T<sub>J(MAX)</sub>=150° C, using junction-to-case thermal resistance, and is more useful in setting the upper dissipation limit for cases where additional heatsinking is used.

C. Repetitive rating, pulse width limited by junction temperature T<sub>J(MAX)</sub>=150° C, Ratings are based on low frequency and duty cycles to keep initial T<sub>J</sub>=25° C.

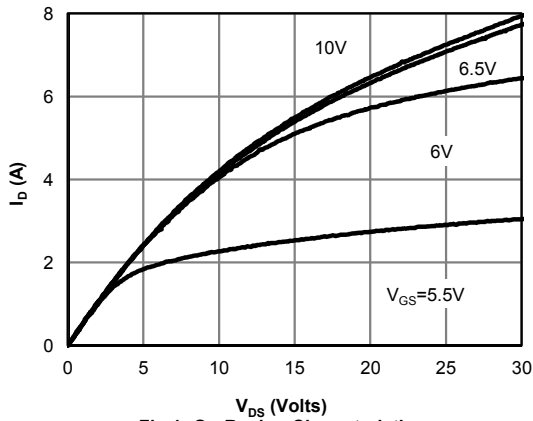
D. The R<sub>θJA</sub> is the sum of the thermal impedance from junction to case R<sub>θJC</sub> and case to ambient.

E. The static characteristics in Figures 1 to 6 are obtained using <300 μs pulses, duty cycle 0.5% max.

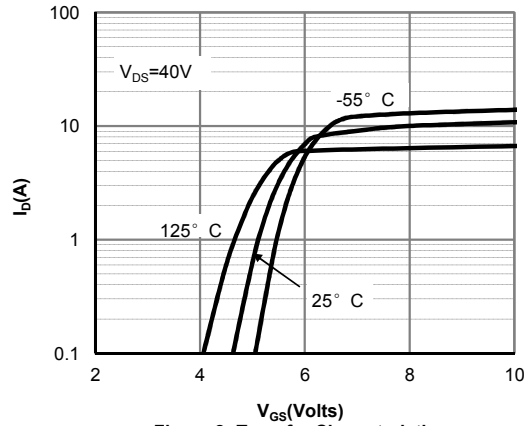
F. These curves are based on the junction-to-case thermal impedance which is measured with the device mounted to a large heatsink, assuming a maximum junction temperature of T<sub>J(MAX)</sub>=150° C. The SOA curve provides a single pulse rating.

G. L=60mH, I<sub>AS</sub>=2.5A, V<sub>DD</sub>=150V, R<sub>G</sub>=25Ω, Starting T<sub>J</sub>=25° C

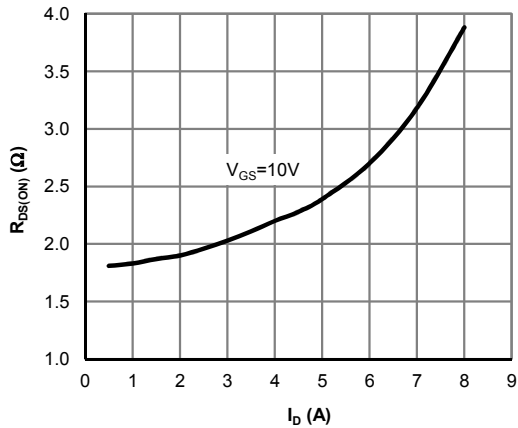
**TYPICAL ELECTRICAL AND THERMAL CHARACTERISTICS**



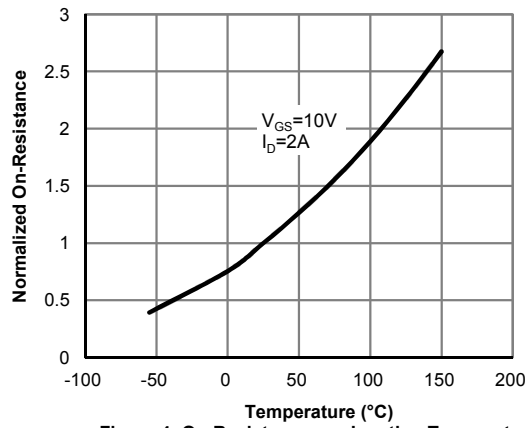
**Fig 1: On-Region Characteristics**



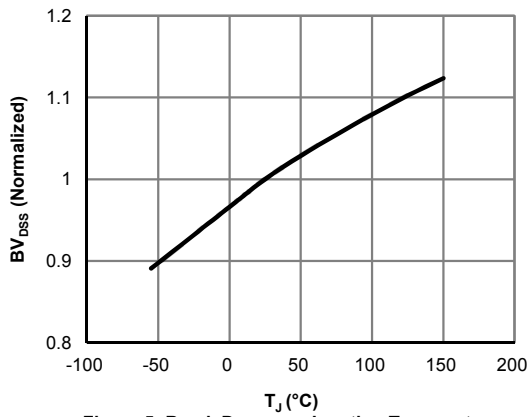
**Figure 2: Transfer Characteristics**



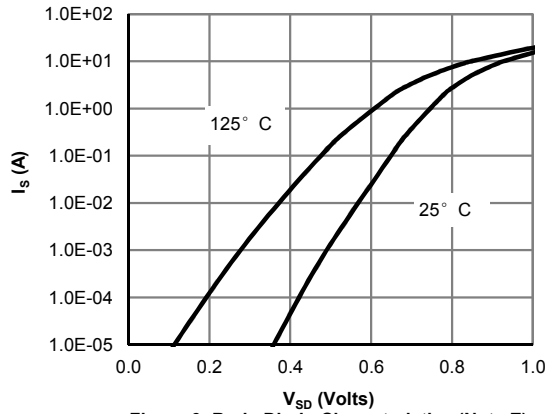
**Figure 3: On-Resistance vs. Drain Current and Gate Voltage**



**Figure 4: On-Resistance vs. Junction Temperature**

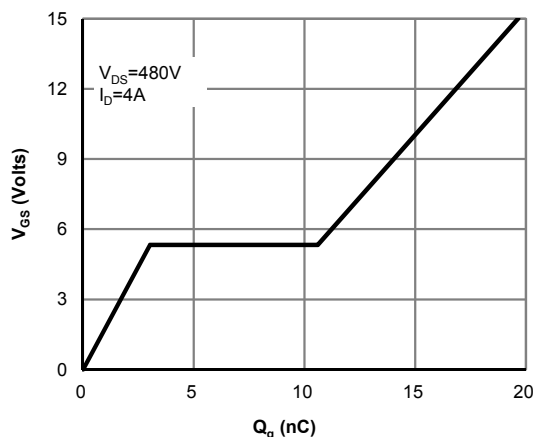


**Figure 5: Break Down vs. Junction Temperature**

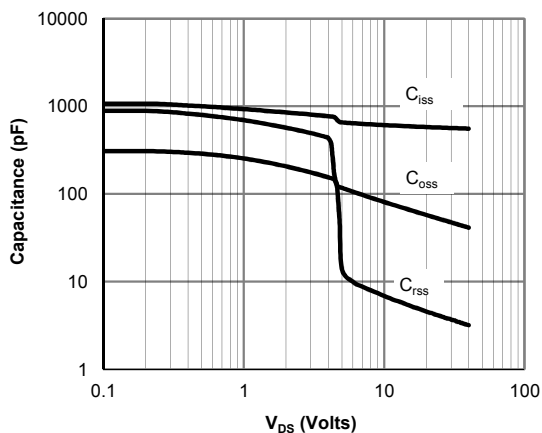


**Figure 6: Body-Diode Characteristics (Note E)**

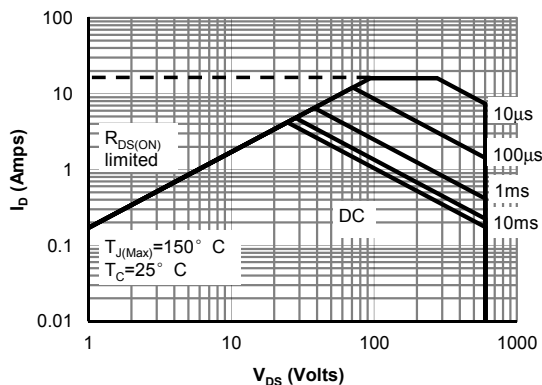
**TYPICAL ELECTRICAL AND THERMAL CHARACTERISTICS**



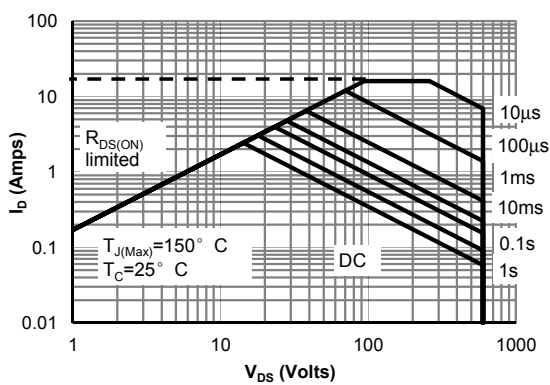
**Figure 7: Gate-Charge Characteristics**



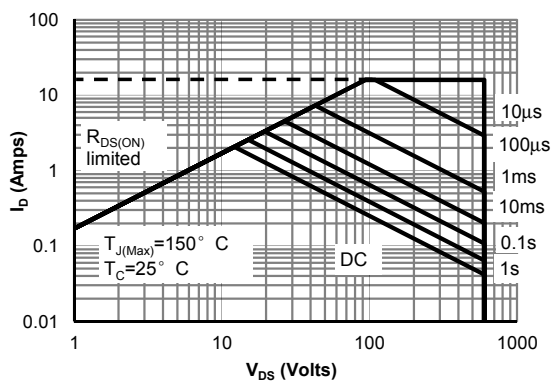
**Figure 8: Capacitance Characteristics**



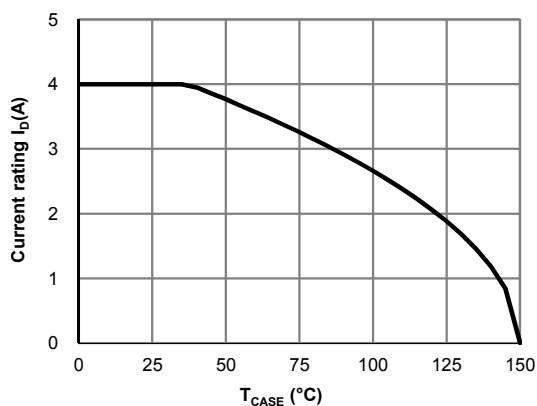
**Figure 9: Maximum Forward Biased Safe Operating Area for AOT4N60 (Note F)**



**Figure 10: Maximum Forward Biased Safe Operating Area for AOTF4N60 (Note F)**

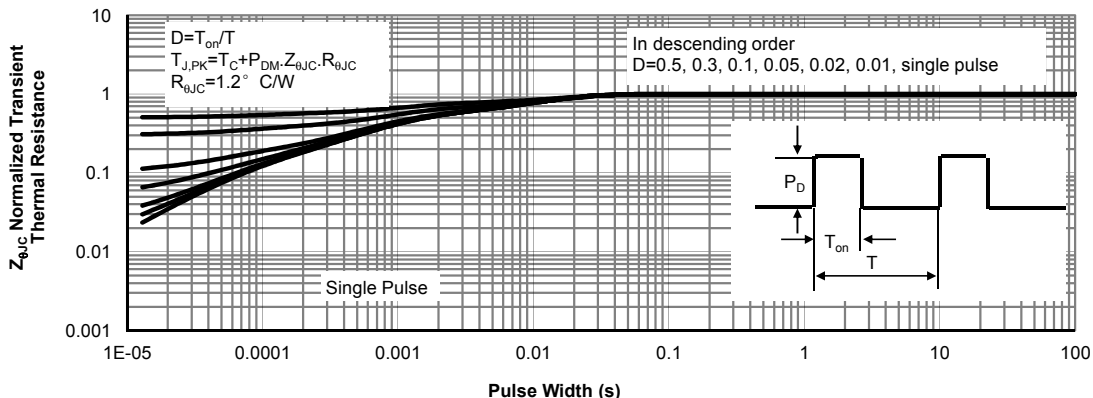


**Figure 11: Maximum Forward Biased Safe Operating Area for AOTF4N60L (Note F)**

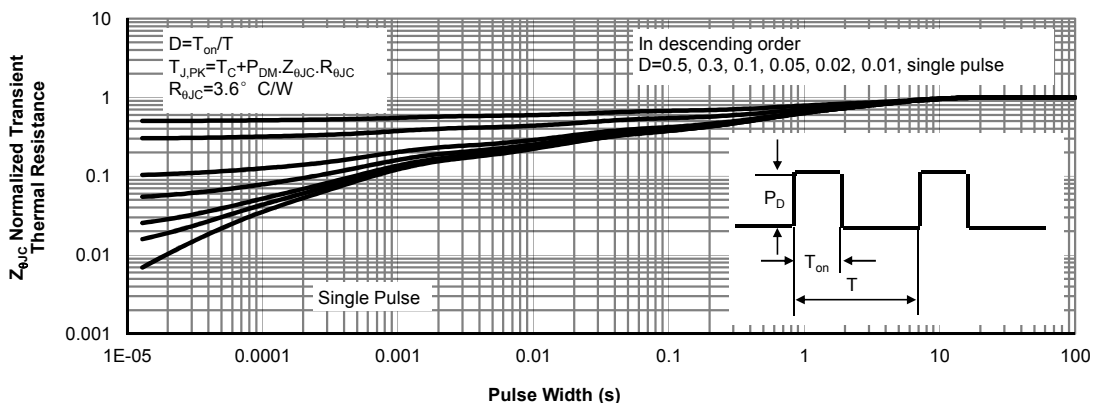


**Figure 12: Current De-rating (Note B)**

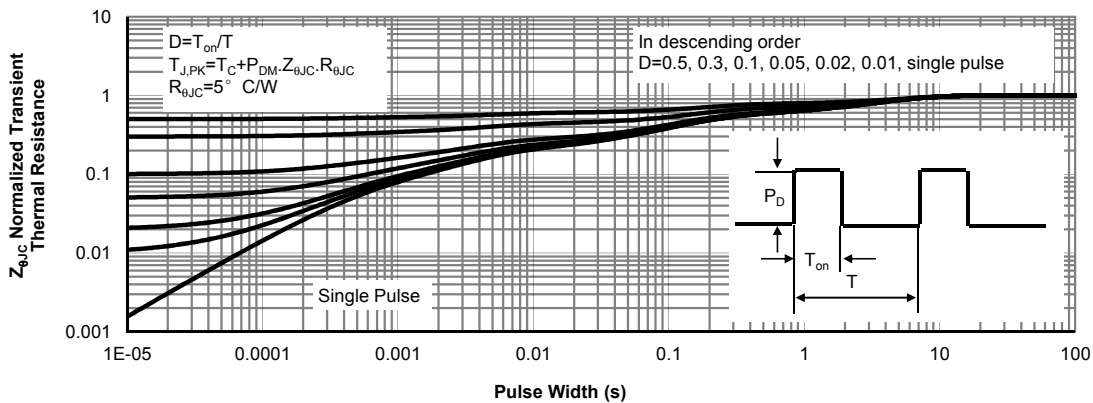
**TYPICAL ELECTRICAL AND THERMAL CHARACTERISTICS**



**Figure 13: Normalized Maximum Transient Thermal Impedance for AOT4N60 (Note F)**

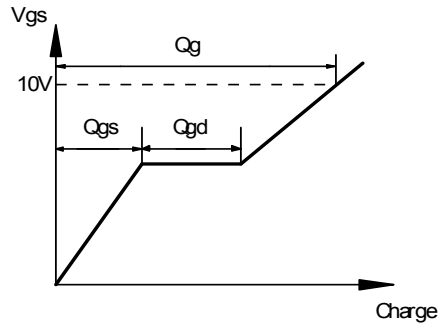
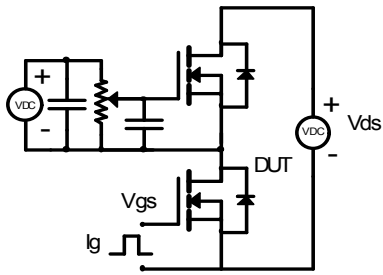


**Figure 14: Normalized Maximum Transient Thermal Impedance for AOTF4N60 (Note F)**

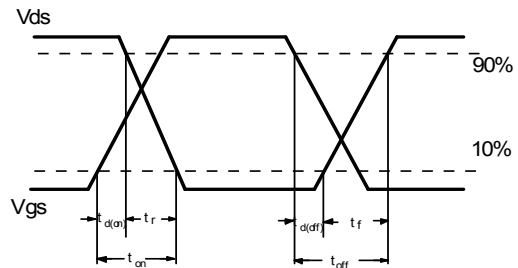
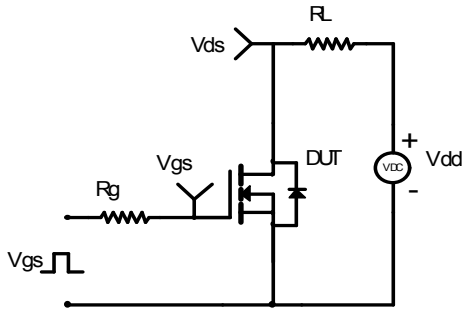


**Figure 15: Normalized Maximum Transient Thermal Impedance for AOTF4N60L (Note F)**

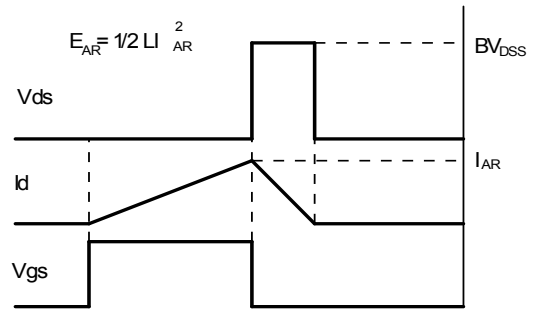
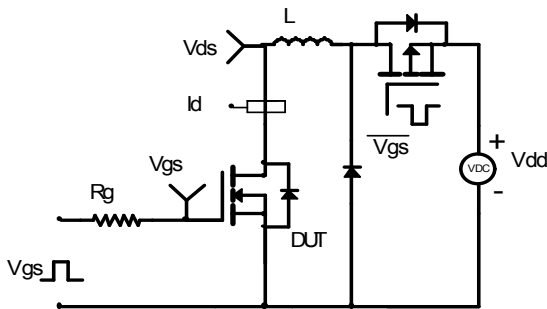
### Gate Charge Test Circuit & Waveform



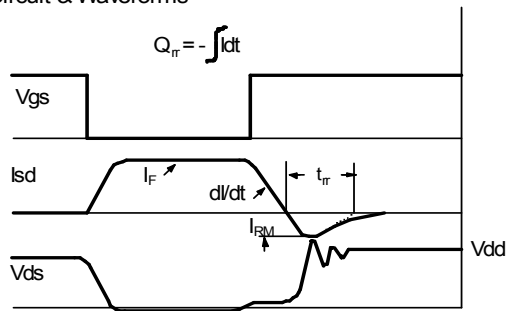
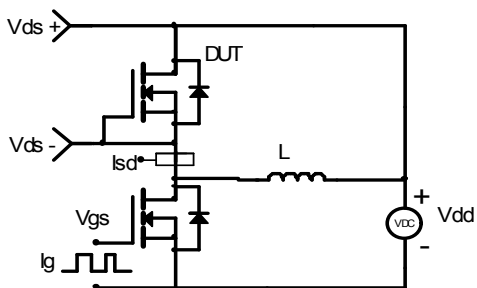
### Resistive Switching Test Circuit & Waveforms



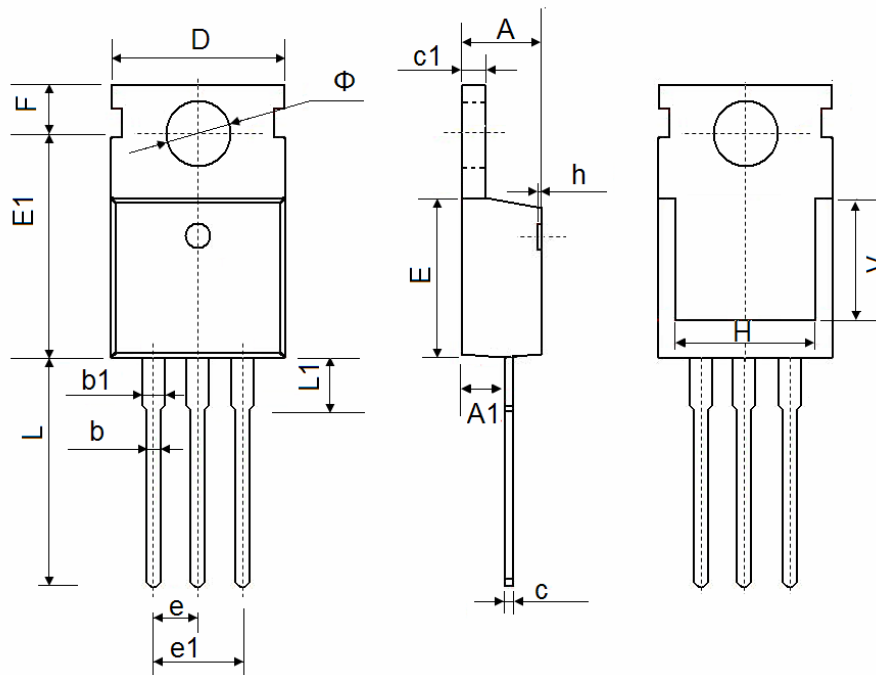
### Unclamped Inductive Switching (UIS) Test Circuit & Waveforms



### Diode Recovery Test Circuit & Waveforms



## TO-220AB Package Information



Symbol	Dimensions In Millimeters		Dimensions In Inches	
	Min.	Max.	Min.	Max.
A	4.400	4.600	0.173	0.181
A1	2.250	2.550	0.089	0.100
b	0.710	0.910	0.028	0.036
b1	1.170	1.370	0.046	0.054
c	0.330	0.650	0.013	0.026
c1	1.200	1.400	0.047	0.055
D	9.910	10.250	0.390	0.404
E	8.9500	9.750	0.352	0.384
E1	12.650	12.950	0.498	0.510
e	2.540 TYP.		0.100 TYP.	
e1	4.980	5.180	0.196	0.204
F	2.650	2.950	0.104	0.116
H	7.900	8.100	0.311	0.319
h	0.000	0.300	0.000	0.012
L	12.900	13.400	0.508	0.528
L1	2.850	3.250	0.112	0.128
V	7.500 REF.		0.295 REF.	
Φ	3.400	3.800	0.134	0.150

## TO-220F Package Information